

DURACELL®

DL2430

Lithium/Manganese Dioxide Battery

Li/MnO₂

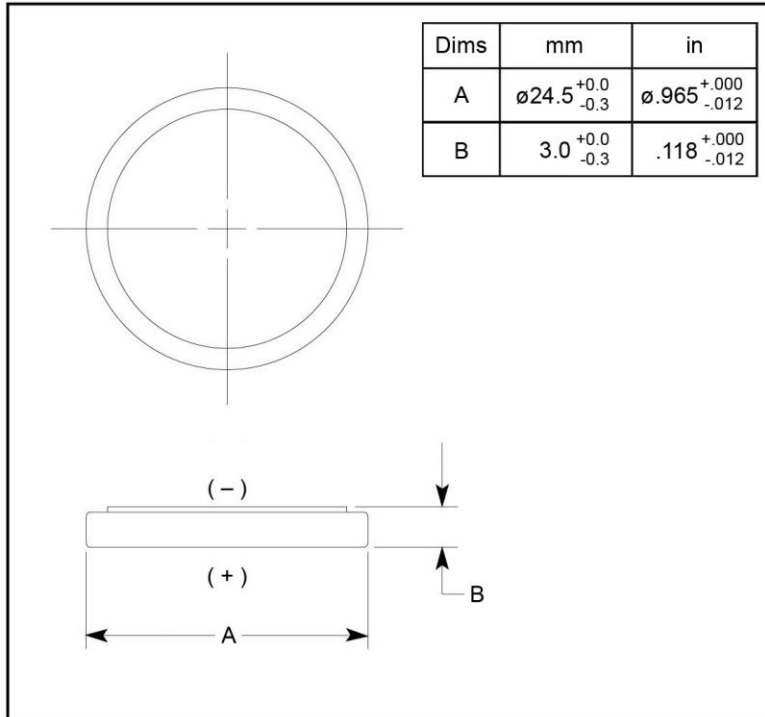

SPECIFICATIONS

Nominal Voltage: 3.0 V

Typical Voltage: 3.1 – 3.3 V

Rated Capacity: 270 mAh on
15 k Ω to 2.0 V

Average Weight: 4.5 g (0.159 oz.)

Terminals: Flat

Operating Temp. Range: -20°C to 60°C
(-4°F to 140°F)

NEDA/ANSI: 5011LC
IEC: CR2430

Discharge Characteristics

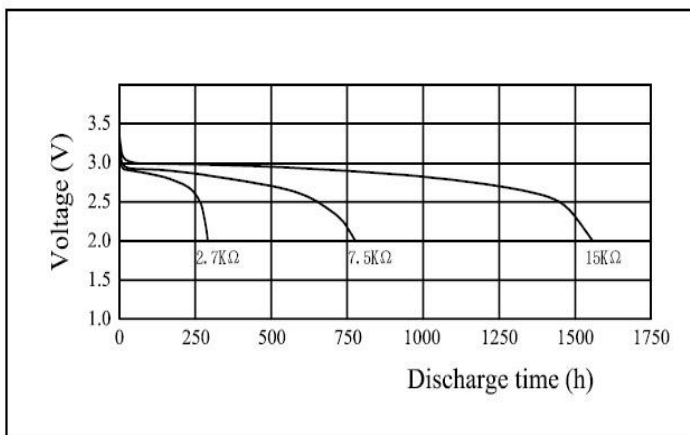

Temperature Characteristics

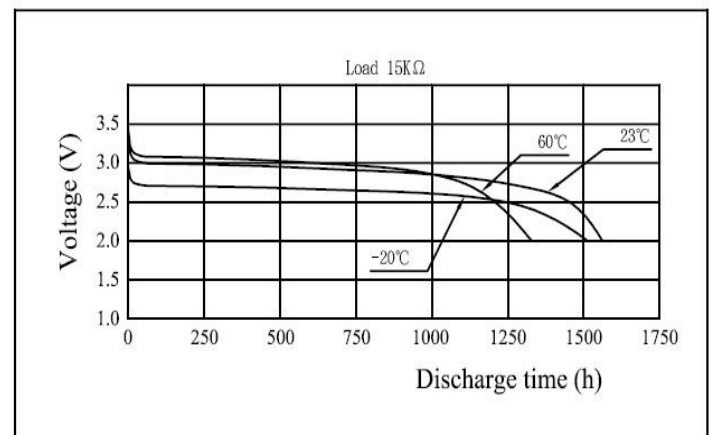

DURACELL®

BATTERIES

Berkshire Corporate Park
Bethel, CT. 06801 U.S.A.
Telephone: Toll-free 1-800-544-5454
www.duracell.com

Delivered capacity is dependent on the applied load, operating temperature and cut-off voltage. Please refer to the charts and discharge data shown for examples of the energy/service life that the battery will provide for various load conditions.

Load vs. Operating Voltage

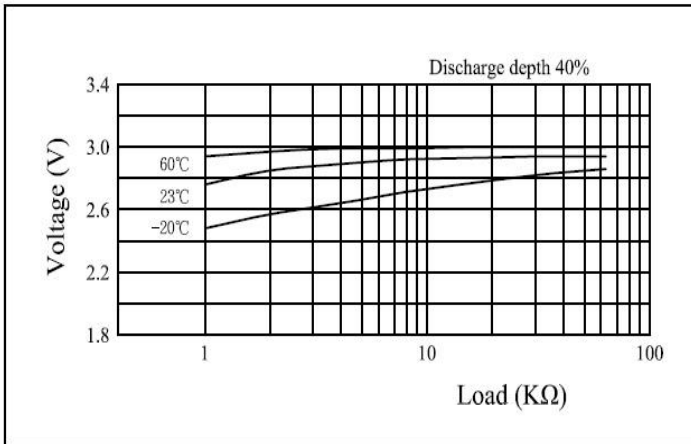

Load vs. Capacity

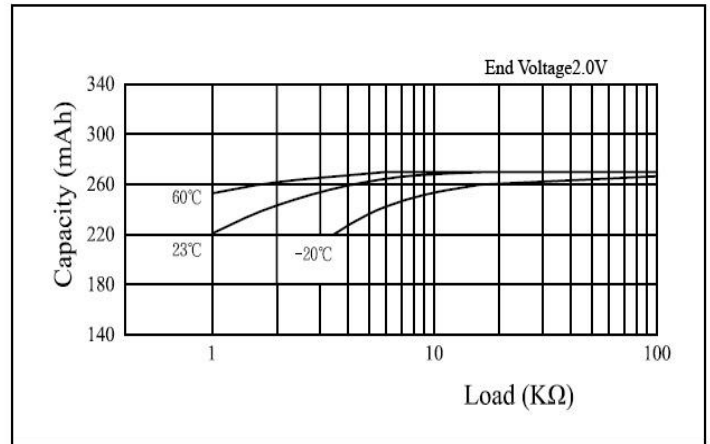

Pulse Discharge Characteristics

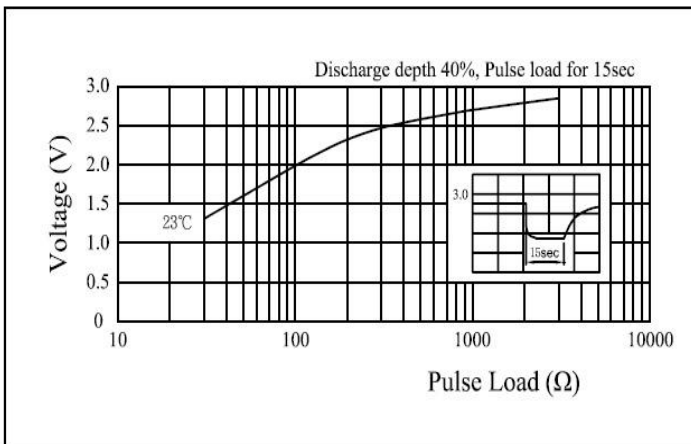

Storage Characteristics

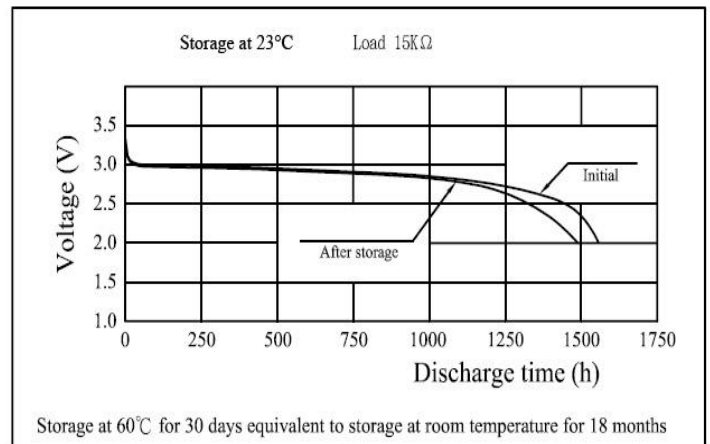

DURACELL®

BATTERIES

Berkshire Corporate Park
Bethel, CT. 06801 U.S.A.
Telephone: Toll-free 1-800-544-5454
www.duracell.com

Delivered capacity is dependent on the applied load, operating temperature and cut-off voltage. Please refer to the charts and discharge data shown for examples of the energy/service life that the battery will provide for various load conditions.